

**Swegon Air Academy Seminar. Tallinn.
2015 December 3**

The new ASHRAE-REHVA Active and Passive Beam Application Design Guide

Carlos Lisboa



carlos.lisboa@blcnavitas.pt

Office +351 214 415 546

Cell +351 919 263 880

Learning Objectives

- Understand how a chilled beam system functions;
- Understand the advantages of the application of chilled beam systems;
- Understand design considerations when determining whether a project is a good chilled beam candidate;
- Understand how to control chilled beam systems;
- Understand condensation risks and control strategies to prevent condensation;
- Understand how beam systems can reduce building energy consumption, maintenance and replacement costs.

History

- REHVA Guide published in 2004
- ASHRAE intention to draft a guide
- Motivation to draft one book for the industry
 - Consistent
 - Updated
 - Range of experience

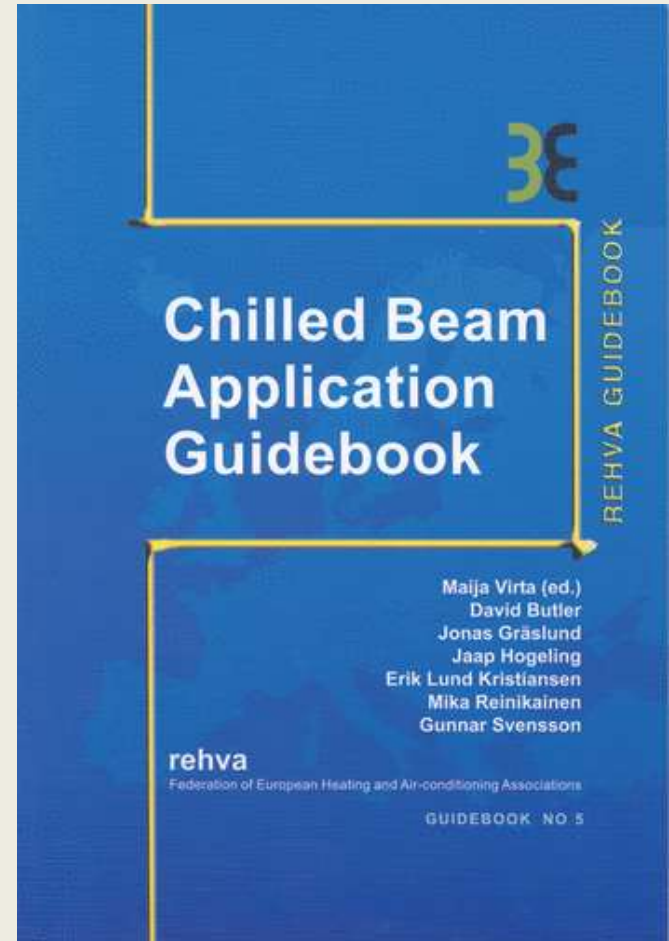

History

- Committee formed at the Albuquerque meeting in 2010.
- Consisted of members of both ASHRAE and REHVA
 - Consultants (6)
 - Manufacturers (7)
- 10 face-to-face meetings
- Numerous teleconference meetings
- Publication submitted to ASHRAE at the New York 2014 winter meeting, in January
- Submitted simultaneously to REHVA

Beam GuideBook Committee

ASHRAE	REHVA
Julian Rimmer (Chair), Price Industries	John Woollett (Chair), Swegon
Darren Alexander, Twa Panel Systems	Mick Holland, Ability Projects
Jonathan Chan, BR+A	Carlos Lisboa, BLC Navitas
Ken Loudermilk, Trox USA	Risto Kosonen, Halton
Chris Lowell, Halton USA	Slawomir Sawicki, Pol-Con Consulting
Peter Simmonds, IBE Consulting Engineers	Rafael Úrculo, Urculo Ingenieros, SA
	Maija Virta
	Thomas Wolters, Trox

Active Beam Concept

- Primary air is supplied to beam plenum and forced through jet nozzles
- Room air is induced and forced through water coil (cooling or heating)
- Mix of primary and cooled secondary air is supplied through an air diffuser

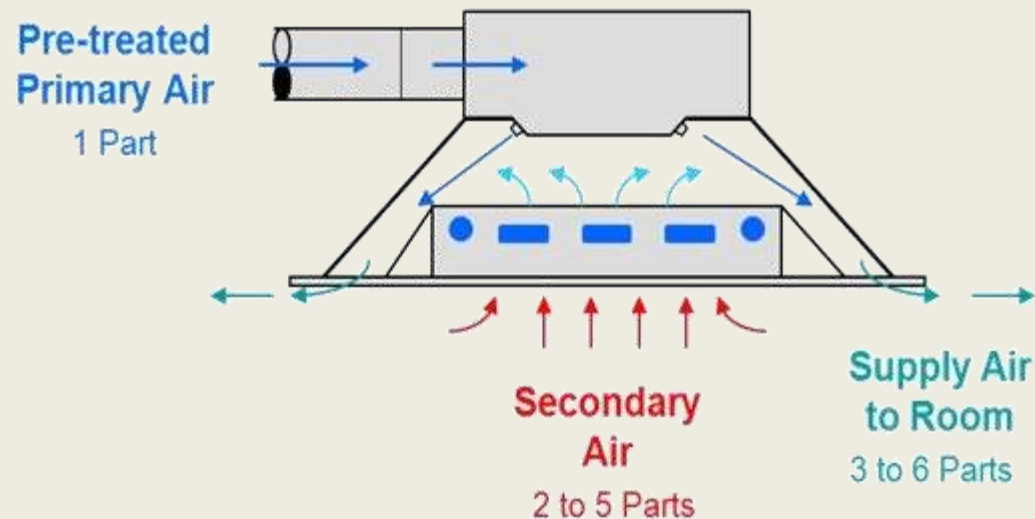

Active Beam Designs

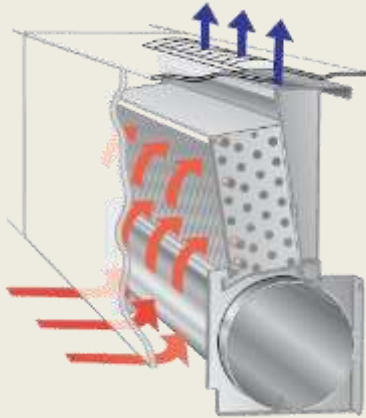

**Perimeter wall
instalation
(under the
window sill)**

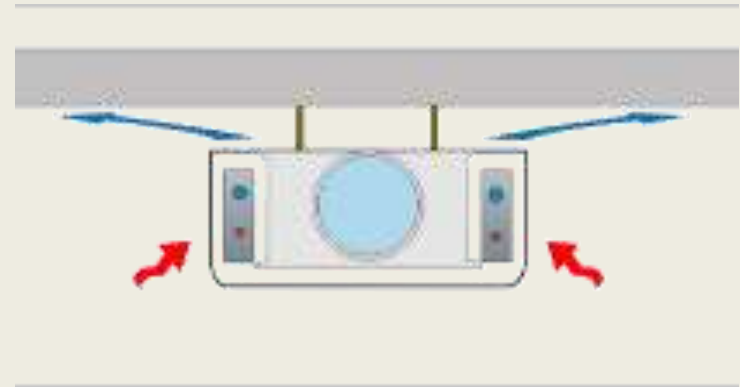

Exposed installation

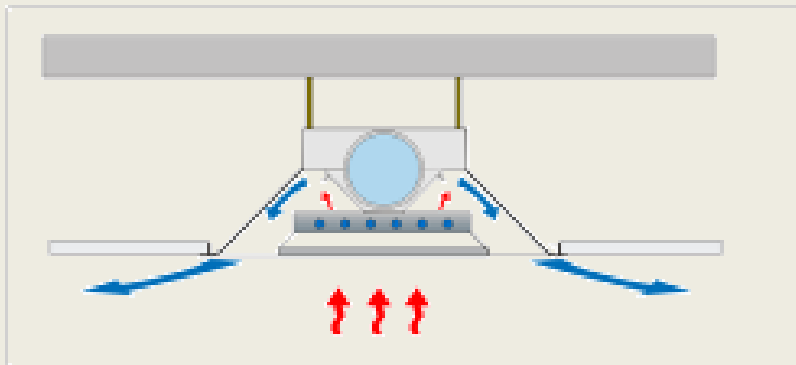

Recessed installation

- Four way;
- Hotel room;
- Under floor;
- etc.

Passive Beam Concept

- Buoyancy forces promote the circulation of room air through the chilled water coil
- No primary air is supplied to the beam

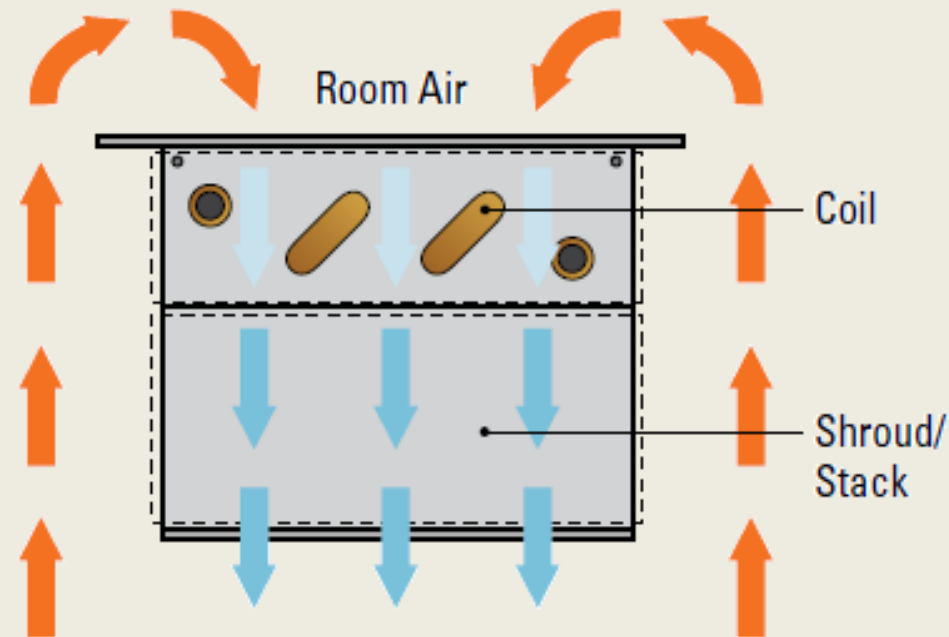
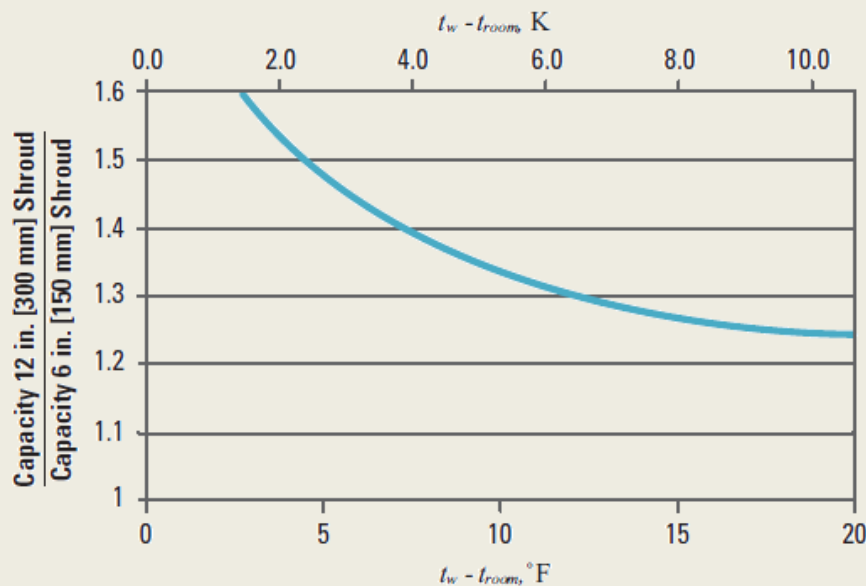

Passive Beam Concept

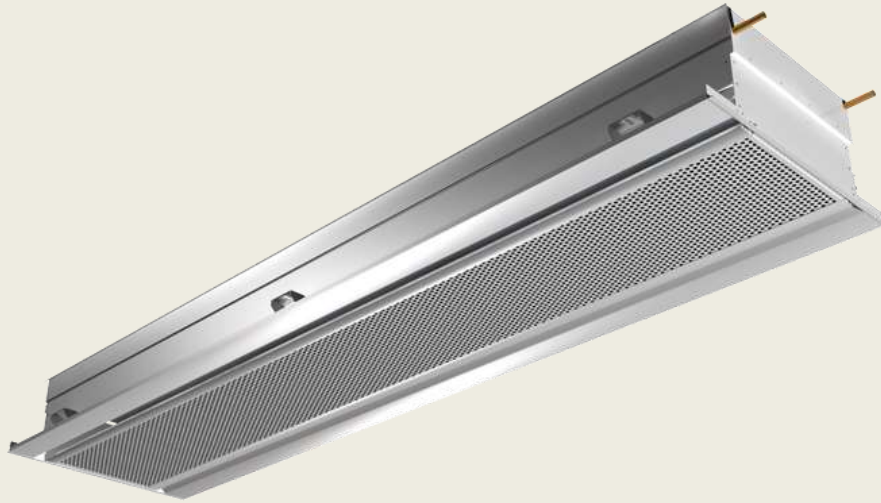

Passive chilled beam for recessed installation

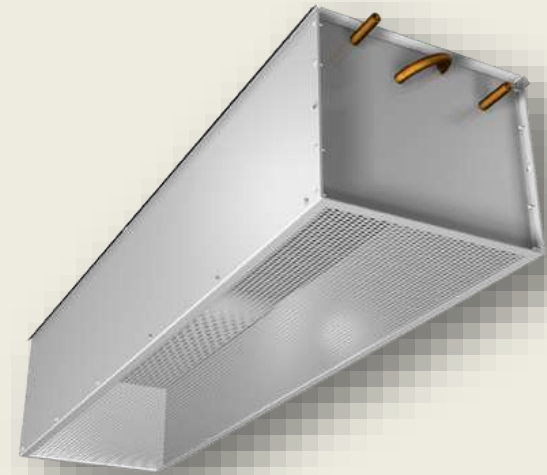

Passive chilled beam for exposed installation

Beam System concept

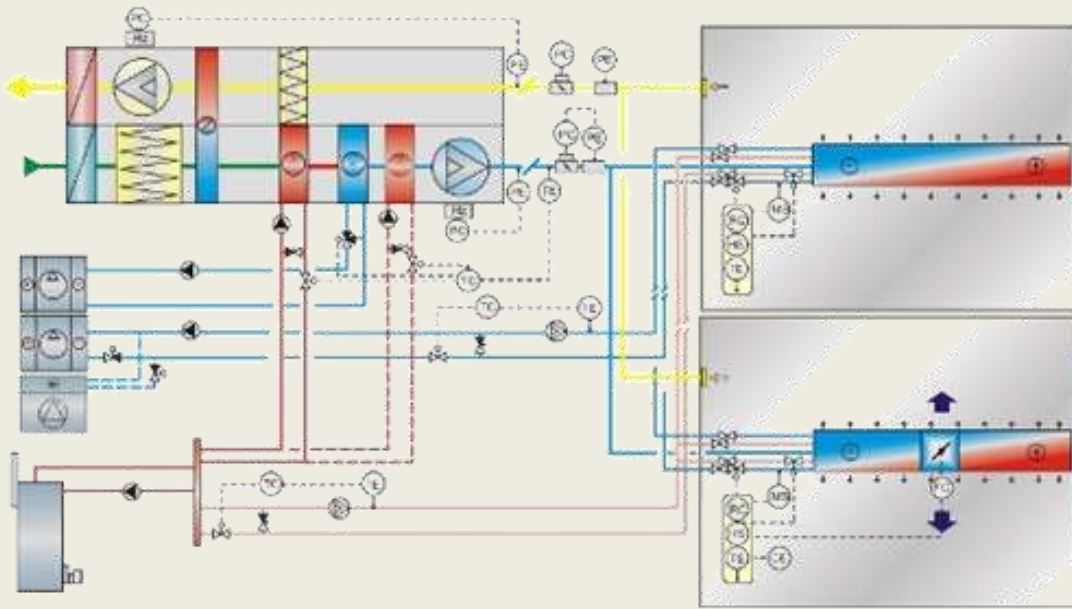

- Beam functions:
 - Room sensible cooling;
 - Room heating;
 - Room air distribution.
- Primary air system functions:
 - Ventilation;
 - Ventilation loads;
 - Room dehumidification (latent load);
 - Room sensible cooling (**small %**).

Beam System concept

- Typical values:
 - Passive Beams up to 150 W/m;
 - Active Beams up to 180 W/m²;
 - Chilled water 14°C to 18°C;
 - Hot water 30°C to 45°C;
 - Primary air temperature 13°C to 21°C;
 - Beam plenum pressure 50 Pa to 250 Pa;
 - Room sensible cooling by the chilled beam water coil $\geq 60\%$;
- Non-condensing coils at the room level;
- Condensation prevention strategy required.

Beam System Applications

The energy benefits of a Beam System are maximized whenever the following conditions are met:

- Moderate room sensible loads ($<100\text{W}/\text{m}^2$);
- Moderate and controlled room latent load;
- Low air-side load fraction;

(When a significant amount of primary air is required for sensible cooling, dehumidification or ventilation the energy benefit of a high temperature hydronic room cooling system is reduced)

Beam System Applications

Examples of applications:

Office Buildings

Hotel rooms

Patient rooms

Laboratories

Schools

Retail

Beam systems are not well suited for places where humidity/latent loads are difficult to control or places with particularly high loads:

- Areas of ingress/egress of buildings
- Leaky buildings
- Auditoriums

Beam System Applications

**Recessed Active Beams installed
in an acoustical ceiling**



**Exposed MultiService Passive
Beam with integrated lighting**

Beam System Applications

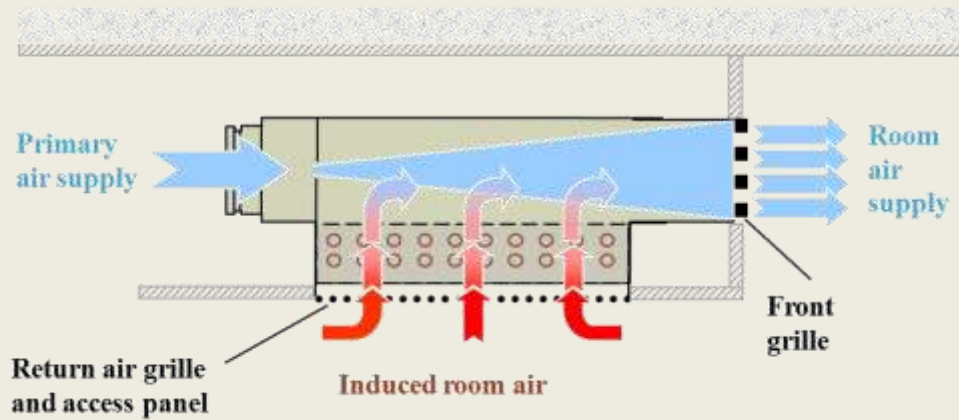

Hotel room



Lab Application



Primary air flow calculation

Primary air flow has the following functions and corresponding requirements:

Function	Goal	Requirements
Ventilation	<ul style="list-style-type: none">•Comfort•Health	<ul style="list-style-type: none">•Local code,•Owner Project Requirements
Indoor air dehumidification	<ul style="list-style-type: none">•Comfort•Condensation control	<ul style="list-style-type: none">•Indoor air humidity inside comfort range•Indoor air dewpoint equal or under chilled water temperature supplied to the beams
Space cooling	<ul style="list-style-type: none">•Comfort	<ul style="list-style-type: none">•Indoor air temperature inside comfort range

Primary air flow rate needed for each of the three functions must be calculated. Design primary air flow is the highest value of the three.

Ideally primary air flow rate should be as close as possible to the air flow calculated to comply with the ventilation requirements.

Primary air flow calculation

Primary air flow needed for ventilation;

Calculation according to EN15251 – category 2

description	symbol	value	units	formula/source
floor area	A	16,5	m ²	
ceiling height	h	2,8	m	
volume	Vol	46	m ³	$A \times h$
occupancy	NP	1	-	
ventilation per person	R _p	7,0	l / s.p	EN 15251 - category 2
ventilation unit area	R _a	0,70	l / s.m ²	EN 15251 - category 2 ; low polluting
ventilation requirement	V1	19	l/s	EN 15251 : 2007 ($R_p \times NP + R_a \times A$)
Air Changes per Hour	ACH	1,4	/h	$V1 \times 3,6 / Vol$

Very different requirements from different standards

Calculation according to ASHRAE 62.1

description	symbol	value	units	formula/source
occupancy	NP	1	-	
ventilation per person	R _p	2,4	l / s.p	ANSI/ASHRAE 62.1
ventilation unit area	R _a	0,30	l / s.m ²	ANSI/ASHRAE 62.1
ventilation requirement	V1	7,4	l/s	ANSI/ASHRAE 62.1 ; ($R_p \times NP + R_a \times A$)
Air Changes per Hour	ACH	0,6	/h	$V1 \times 3,6 / Vol$

Primary air flow calculation

Dehumidification air flow is usually calculated using steady state conditions.

The consideration of dynamic effects accounting for building and furniture absorption of water vapour results in a lower calculated dehumidification air flow.

Not considering the dynamic effects in the water vapour mass balance results in a conservative calculation, ie, the calculated air flow includes a safety margin.

Primary air flow calculation

In cases of high sensible loads, beam selection may require a primary air flow to the beams above the calculated values for ventilation and for dehumidification.

In these cases, if the percentage of cooling delivered by the primary air is above 40%, a variable primary air strategy should be implemented.

Separate boost diffuser or VAV Beams can be applied.

Control of Beam Systems

Beam System controls include the following:

- Zone control;
- Chilled Beam supply water temperature control;
- Primary air condition control;
- Condensation prevention.

Zone Control

- The primary control of **space temperature** is normally accomplished by varying the water flow in the beam coil while maintaining a constant primary air temperature and flow rate
- Varying the primary airflow to the room, according to the actual occupancy (**DCV**), can significantly reduce the system energy consumption; by minimising the AHU energy consumption and reheat energy to avoid overcooling in low occupancy periods

Chilled water temperature control

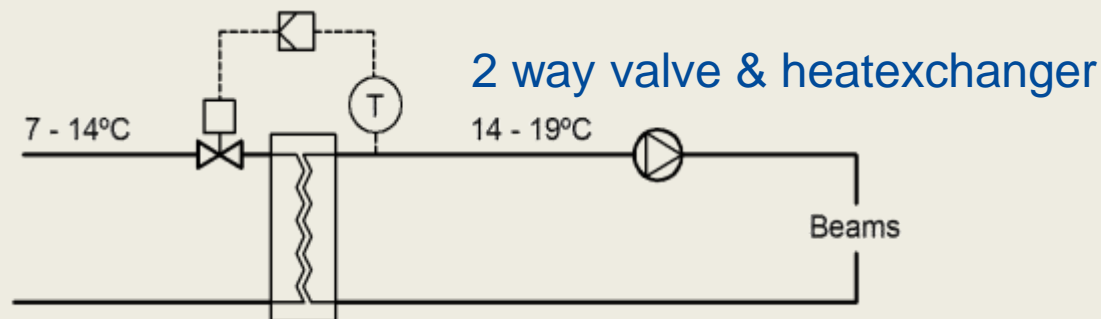
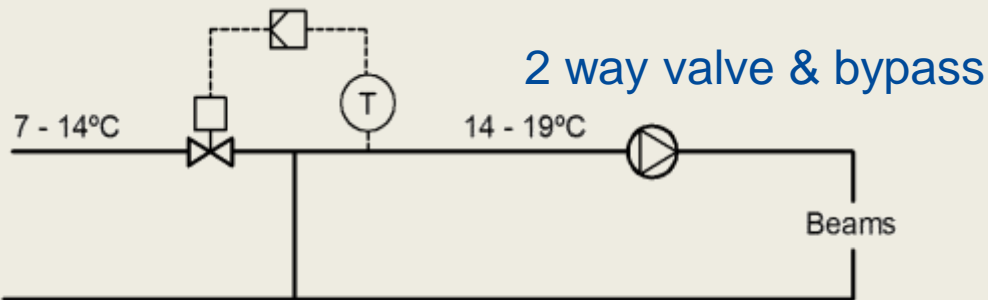
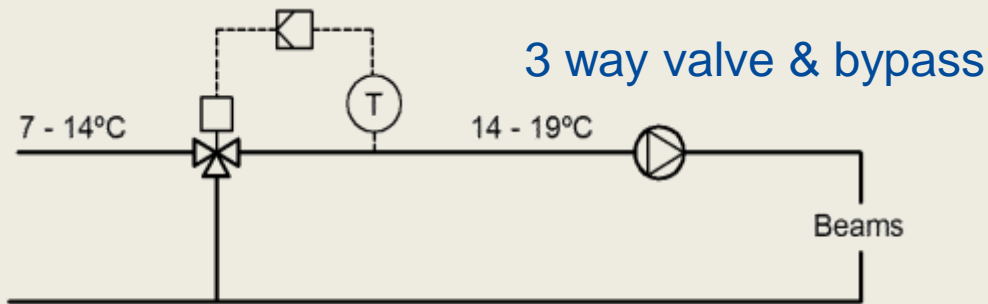

Quality chilled water temperature control is necessary to prevent condensation risk, maintaining chilled water temperature at or above indoor air dewpoint.

Primary air condition Control

- Control of the building humidity level is paramount when beam systems are used
- Humidity control is solely provided by the primary air delivered by the AHU
- In order to avoid the risk of condensate formation on the beams, besides primary air temperature control, the AHU must condition the primary air so that the design primary air dew point is not exceeded

Condensation prevention

The formation, and subsequent falling, of water droplets on the coil surface lags the onset of conditions that could cause condensation.

A rule of thumb from mock-up tests, which have forced condensation to form on the beam's coil surface, showed the **first visible droplet** on the inlet cold pipe to the coil was detected at approximately **2°C** below the indoor air dew point (DP).

Condensation prevention

The occurrence of condensation on the beams is avoided by:

- The supply of an adequate amount of correctly conditioned primary air;
- The implementation of an adequate chilled water temperature control system;
- At morning startup, first turn on the AHU and run the beam CW pump only when the indoor air dew point is below the CWT setpoint.

However, condensation prevention systems are normally applied as a safety measure.

Condensation prevention

Safety condensation prevention can consist on:

- Reactive strategies

installing condensate detectors that:

- stop water supply to the beams;
- Increase CWT setpoint;

- Proactive strategies

- Window switches stopping CW flow;
- Monitoring indoor air DP and resetting CWT setpoint above the measured indoor air DP.

Energy analysis

- Use of dynamic building energy simulation software
- Fully know and understand the technology to be simulated
- Deeply know and understand the calculation method used in the software

Energy analysis

- Specific features that may reduce energy consumption:
 - Higher CWT (13– 17°C) (55-63°F);
 - Lower HWT (32 – 45°C) (90-113°F);
 - Water to transport thermal energy;
 - Absence of excessive uncontrolled dehumidification;
 - Energy efficient room air distribution;
- Specific features that may increase energy consumption:
 - Low CWT temperature differential (Delta T ~ 2°C).

Energy analysis

- Use of higher CWT (13– 17°C) (55-63°F) opportunities:
 - Dedicated chillers (high EER temperature program);
 - Water free-cooling (without compressors) using:
 - Cooling tower;
 - Dry-cooler;
 - Geothermal sources;
 - Increase of CW deltaT in the chillers.

Energy analysis

- Use of lower HWT (32°– 45°C) (90-113°F) opportunities:
 - Condensation boiler;
 - Heat pump (high COP temperature program),
 - Reclaim heat (example; from Data Center cooling);
 - Geothermal sources.

Energy analysis

- Use of water to transport thermal energy;

Energy used to supply 1.000W cooling

description	symbol	cooling with water	cooling with air	units	formula/source
density	ρ	1.000	1,2	kg/m ³	
specific heat	c_p	4,2	1,0	kJ/kg.K	
delta T	ΔT	2	10	K	current value
cooling per (l/s)	cap	8,4	0,012	kW	$\rho \cdot c_p \cdot \Delta T / 1000$
flow per kW cooling	q	0,12	83,33	l/s	1 / cap
fan/pump pressure	P	200	1,5	kPa	current value
fan/pump efficiency (global)	η	0,55	0,55	-	current value
fan/pump power per kW cooling	E	43	227	W / kWclg	$q \cdot P / \eta$

Air requires around 5 times more energy to supply the same cooling capacity

Adds 23% to the sensible cooling load

Energy analysis

- Minimization of latent cooling:
 - In systems using condensing zone coils (wet), dehumidification is often excessive;
 - Dehumidification at the zone coil is usually uncontrolled and increases when the coil surface temperature decreases;
 - In beam systems, zone coils are dry and **dehumidification is performed at the AHU in a controlled manner.**

Energy analysis

- Building simulation model:
 - Make sure all the features are accounted for in the calculation;
 - No building simulation software includes all the possible variations that may occur in an hvac design;
 - Frequently, “workarounds” are necessary to simulate specific features of hvac systems/equipments;
 - Input must be carefully reviewed bearing in mind the software’s calculation methodology;
 - Output must be carefully analysed; ***“assume the simulation is wrong until proven right”***.

Energy analysis

- Variable Primary air flow to the Beams:
 - Recent research in existent buildings show that actual building average occupancy can be as low as **35%** of design occupancy;
 - The implementation of Demand Control Ventilation (DCV) has a huge energy consumption reduction potential, and **should be applied in all kinds of systems**;
 - There are a number of different strategies to apply DCV to Beam systems.

Energy analysis

- DCV in Beam systems:
 - Reduction of primary air to the beams when room is unoccupied;
 - Using occupancy detectors;
 - Low resulting beam plenum pressure shall reduce induction rate and supply air flow, creating the risk of falling air flow jet;
 - Since the room is unoccupied the falling jet causes no comfort issues;
 - Simple and low cost solution;
 - Does not use all DCV energy savings potential.

Energy analysis

- DCV in Beam systems:
 - Reduction of primary air to the beams when room is occupied;
 - Using CO₂ sensors;
 - Primary air is modulated as a control action in the following control loops;
 - *Indoor air CO2 concentration control loop;*
 - *Indoor air temperature control loop;*

This strategy maximizes DCV energy savings potential, minimizing primary air flow and reheat energy.

Capital Expenditures (CAPEX)

- Installation costs
 - Detailed comparison with alternative systems
- Replacement costs
 - 20 years lifetime for beams
- Other costs
 - Not directly related to the HVAC system.

Capital Expenditures (CAPEX)

- Opportunities for other costs reduction:
 - Reduced floor-to-floor height;
 - Relatively small mechanical rooms;
 - Deletion of architectural ceiling;
 - Integrated services (multi-service beam).

Operating Expenditures (OPEX)

- Energy costs:
 - Opportunities related to the use of Beam Systems;
- Maintenance cost:
 - Opportunities related to the use of Beam Systems.

Operating Expenditures (OPEX)

- Features that reduce maintenance costs:
 - No fans&motors at the room level;
 - No filters at the room level;
 - Dry coils at the room level;
 - No condensate drain pans at the room level;
 - No condensate drain piping at the room level;
 - Centralized location of all equipments that require frequent maintenance.

Operating Expenditures (OPEX)

- Typical maintenance routines:
 - Coil cleaning (time interval from 3 to 5 years);
 - Dry cleaning with vacuum equipment;
 - Removal of suspended ceiling not necessary;
 - Elevation equipment not necessary;
 - Control system operation checked (annually).

Beam Systems and Sustainability

The following features make beam systems a relevant contributor for a sustainable building:

- Great energy efficiency minimizing energy use;
- Reduced maintenance requirements, minimizing consumable materials;
- Excellent occupant comfort;
- Long equipment lifetime, minimizing materials and energy use.

Beam Systems and LEED

Beam systems can contribute to achieve the following LEED credits:

- EA-c 1, Optimize energy performance;
- EQ-c 2, Increased ventilation;
- EQ-c 7.1, Thermal comfort, design;
- EQ-c 6.2, Controllability of systems

Beam Systems in renovation

The following features make beam systems a good candidate for building renovation:

- Requires relatively small floor to floor height;
- Requires small mechanical rooms;
- Can dismiss the application of a suspended ceiling (exposed multiservice beam);
- Does not require condensate drainage piping network at the room level (only in mechanical rooms).

Renovation of old induction systems

In the renovation of buildings equipped with old induction systems (noisy and with very limited controllability) the application of contemporary induction units (chilled beams) can be a very cost effective solution.

The existence of buildings with still operable induction units after over 40 year of operation is a proof of the longevity of this type of equipment.

Beam Systems in humid climates

- Active or passive beams operate at the room level;
- When the building envelope has an adequate level of air tightness, **outdoor climate influences predominantly the operation of the primary air handling unit;**
- In all climates, when operable windows are used, window switches should be installed discontinuing the water flow in the beam;
- **Beam systems are adequate for humid climates.**

Acknowledgements

This presentation was prepared based on the work of the BG Committee and partly on past presentations produced by:

- Carlos Lisboa;
- Chris Lowel;
- Ken Lowdermilk;
- Julian Rimmer;
- Rafael Úrculo;
- Risto Kosonen.

Questions?

carlos.lisboa@blcnavitas.pt